

Pattern Projector Lights

Circuit Diagram

LHD

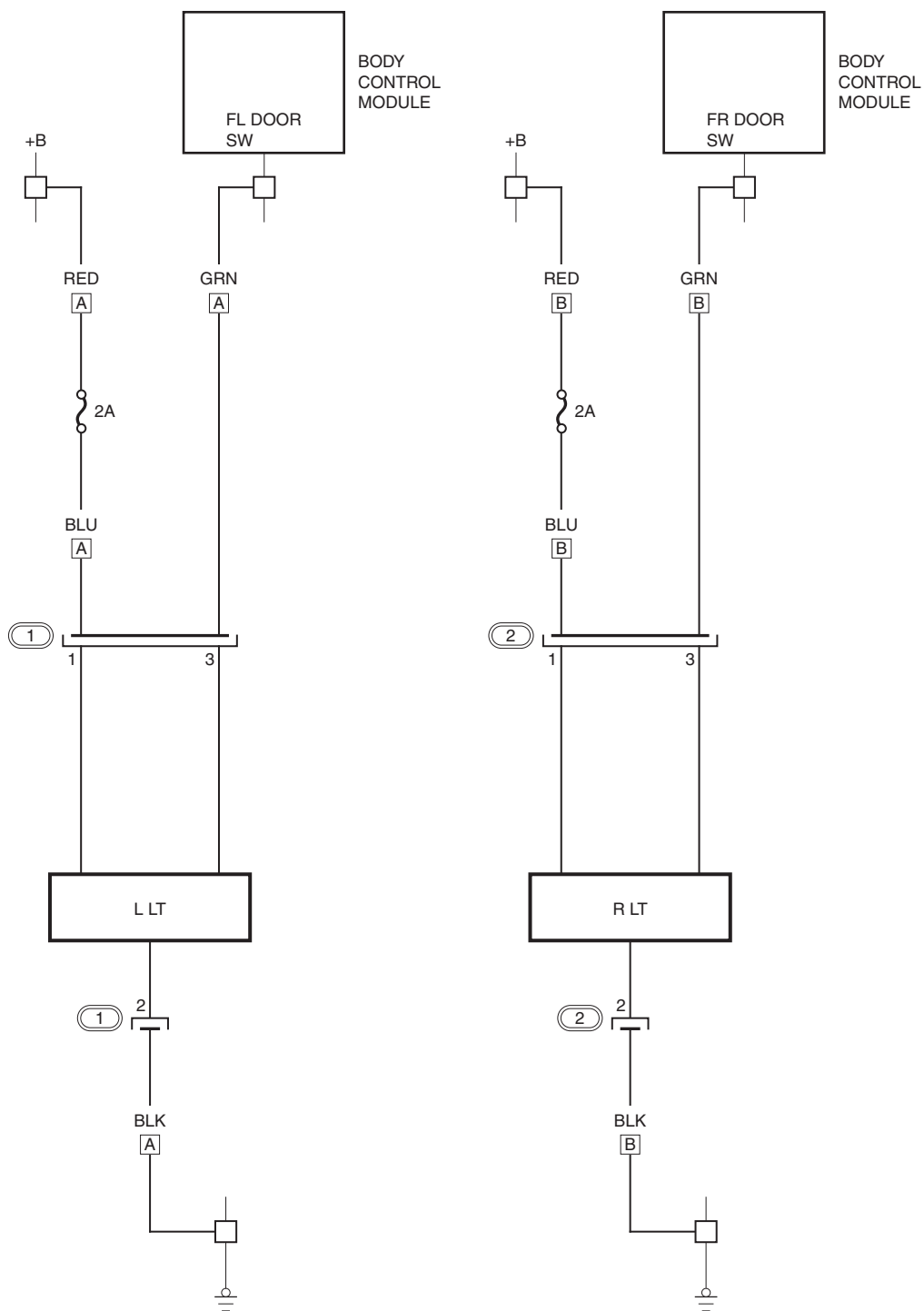

RHD

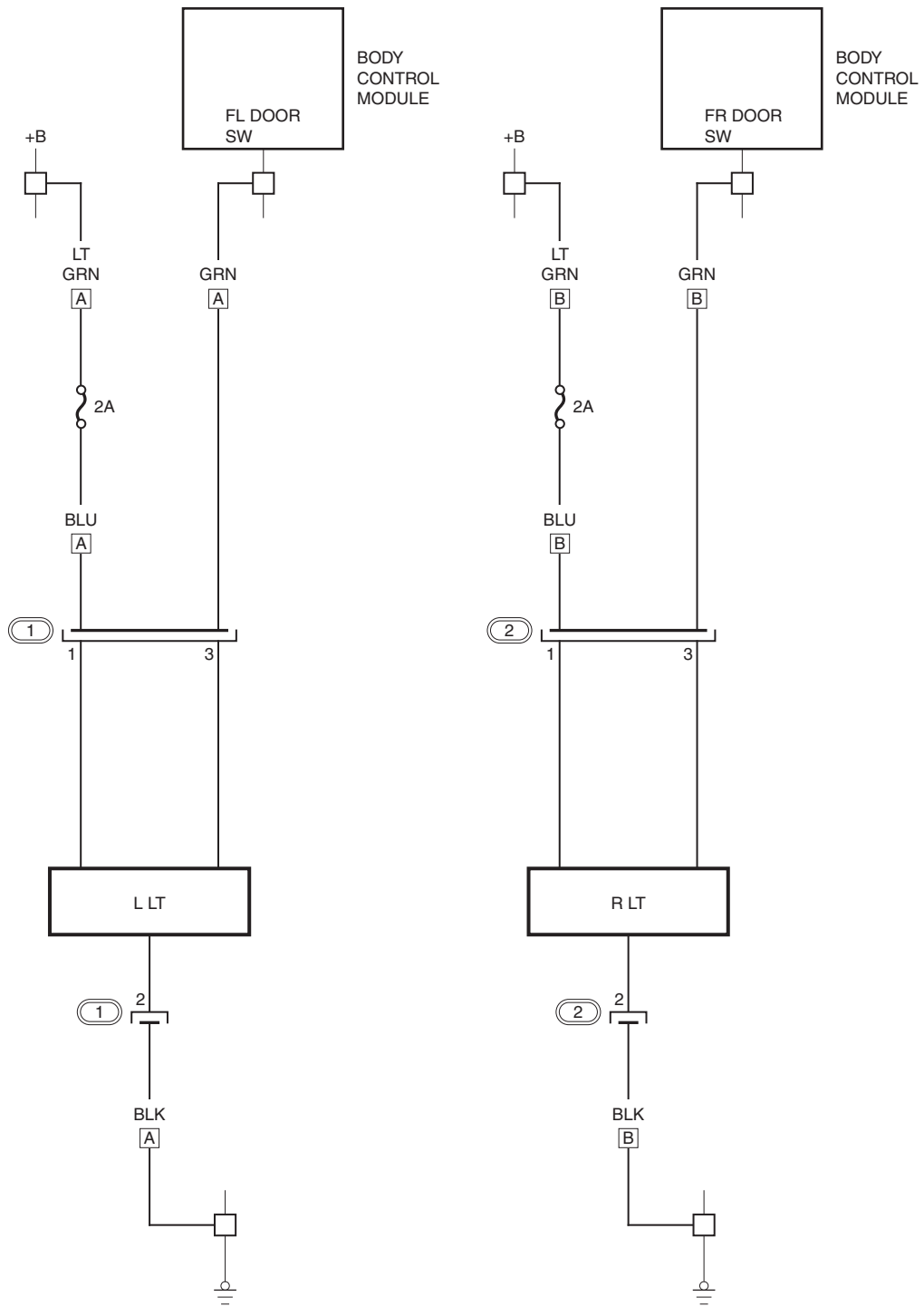

Terminal Arrangement

①

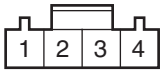

①

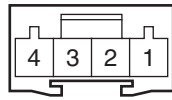

②

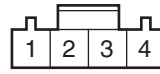

②

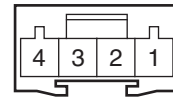

Component Location

LHD

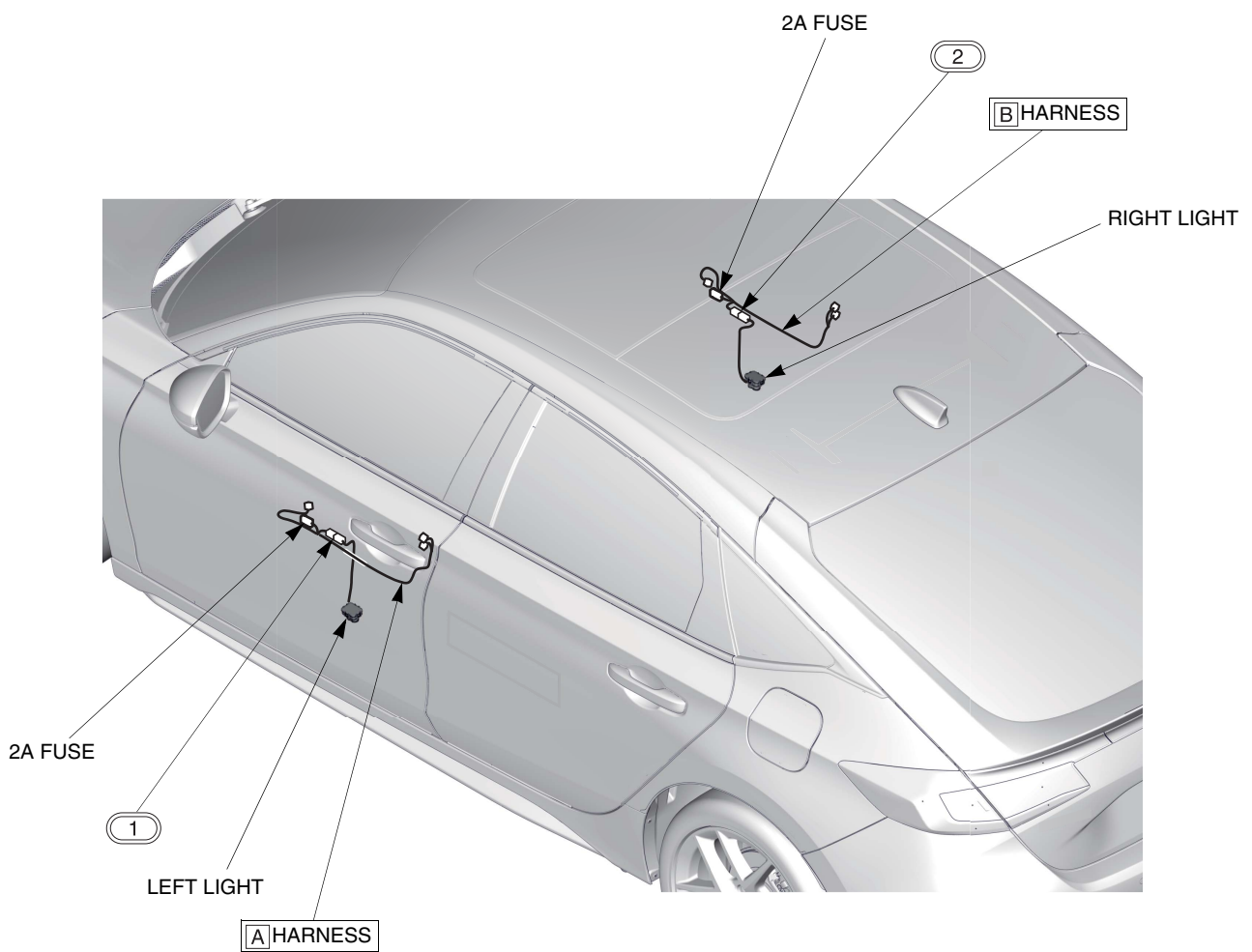

RHD

